

SESTAVLJANJE OKRASNIH PROFILOV HELIMA 2000

OSNOVNE VEZAVE 90°

PROFIL 1808

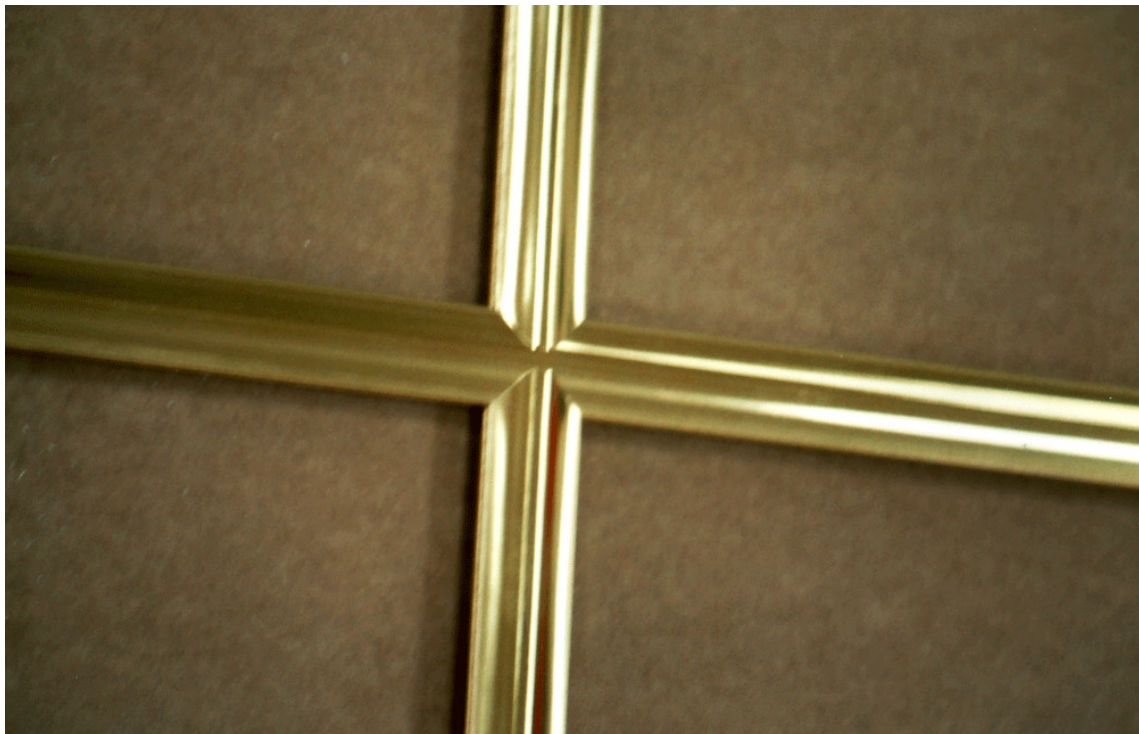

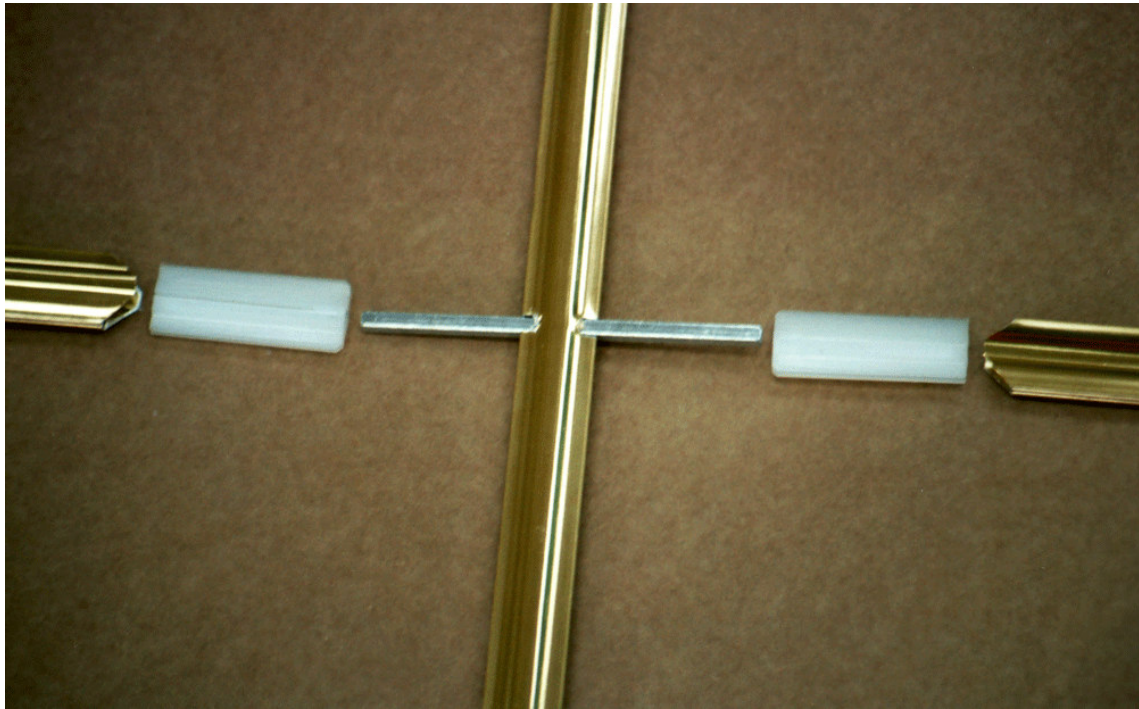
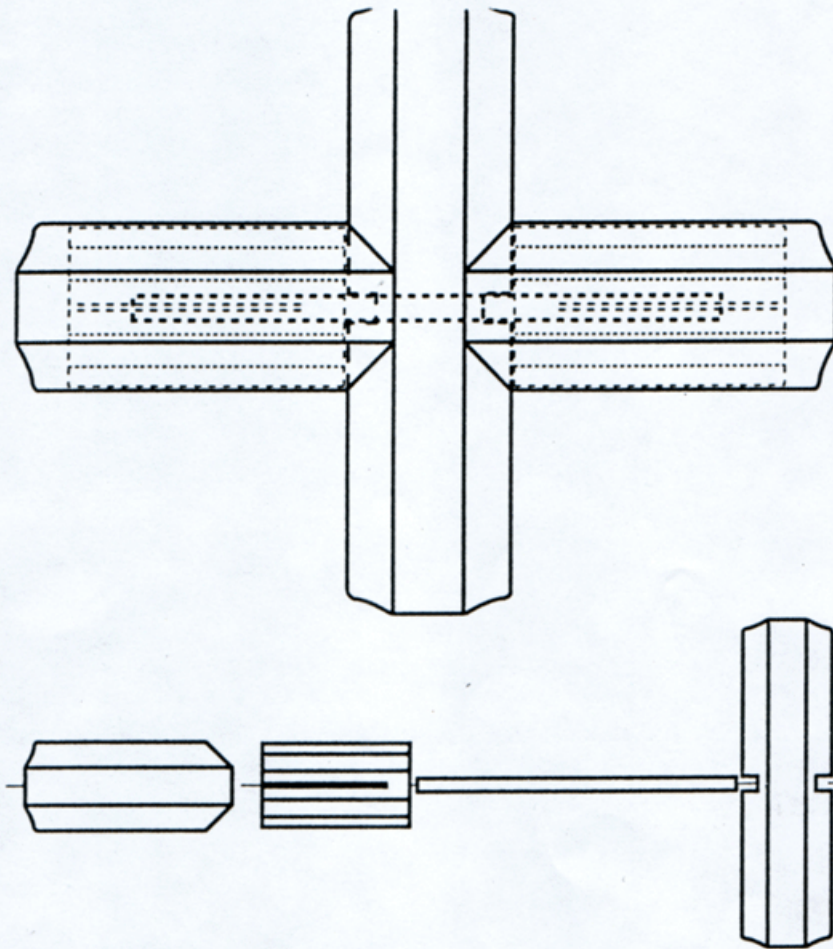

VEZAVA 2000

Sestavlja se z vstavljanjem veznikov v profila, katera povežemo in utrdimo z jeklenim sornikom.

PROFIL 2608

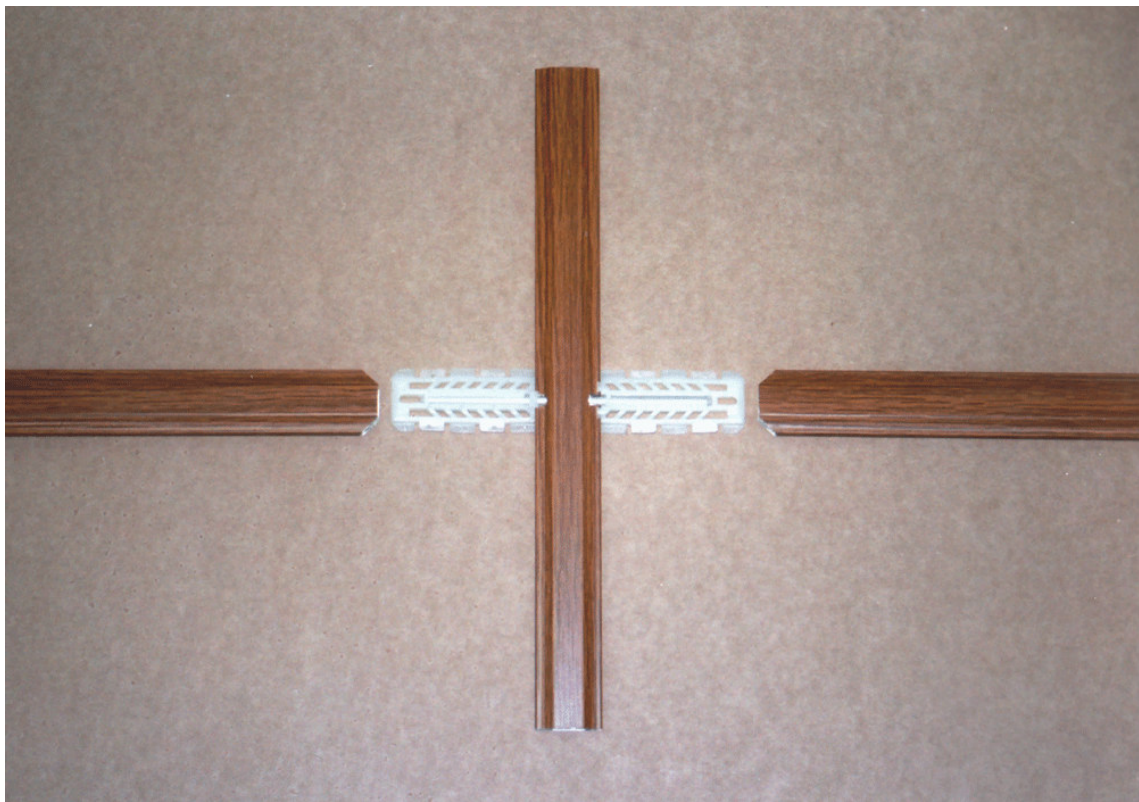
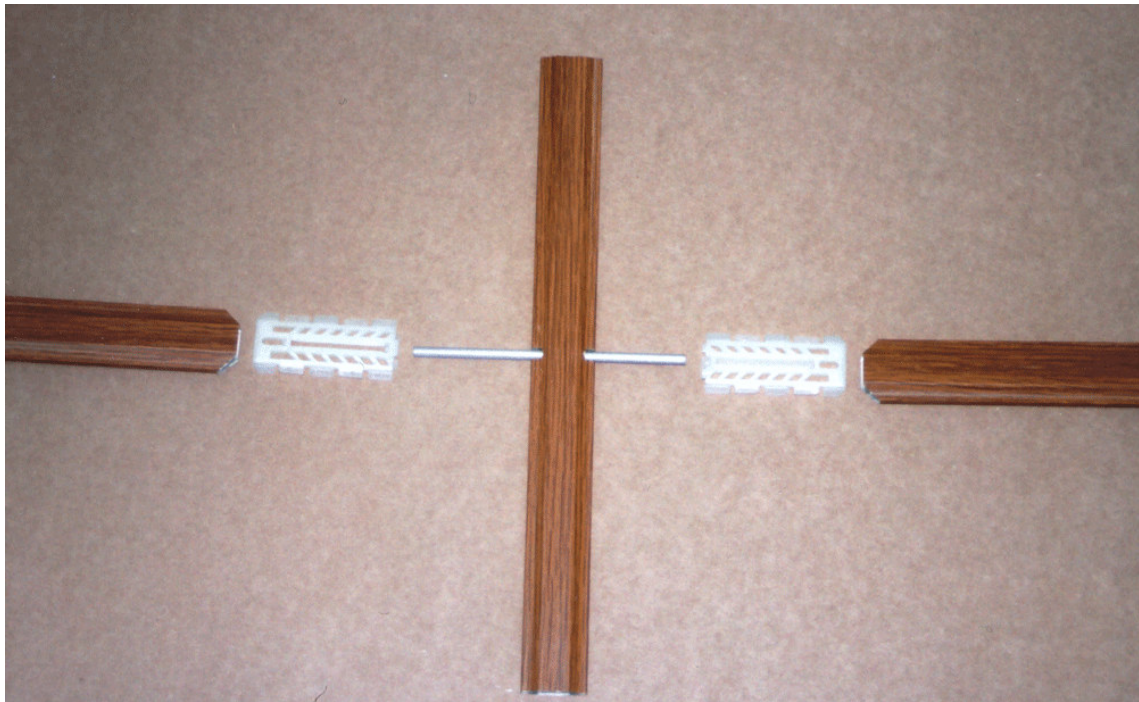

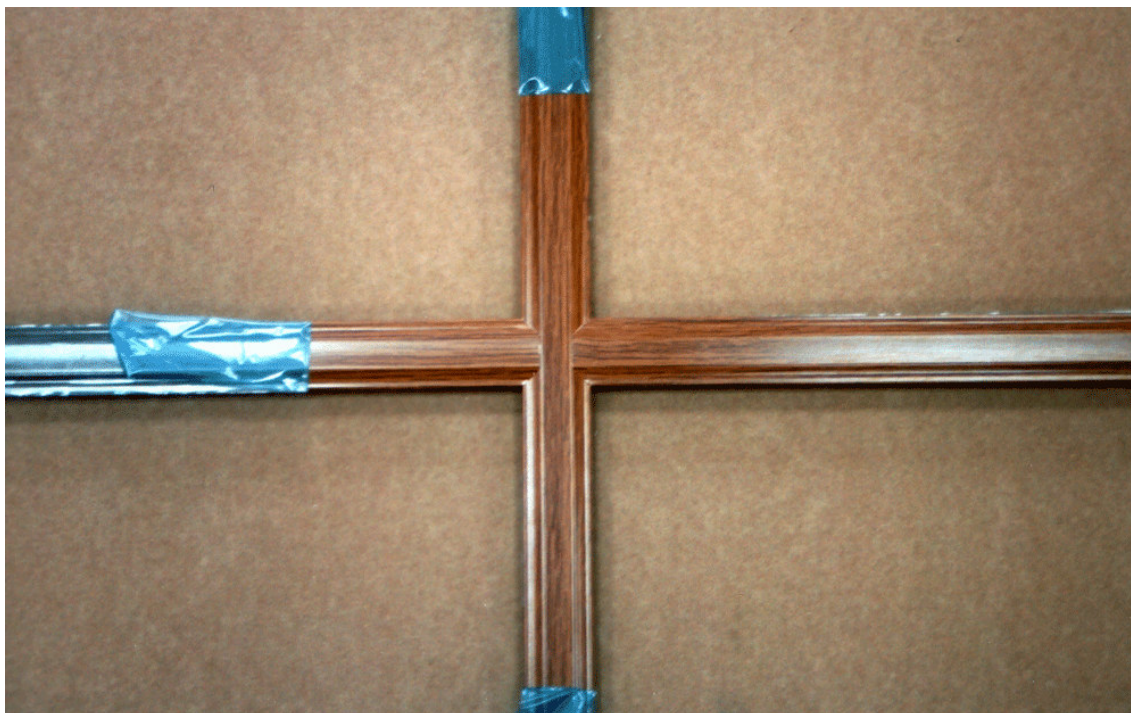

Pri profilu 2608 je sestavljanje poenostavljeno, saj sestavljamo križ tako, da veznika in Alu sornik sestavimo na vertikali in nato natakemo bočna profila.

Odlika tega novega sistema je predvsem, zaradi uporabe sornika iz lahke kovine, v teži in v enostavnem sestavljanju spoja.

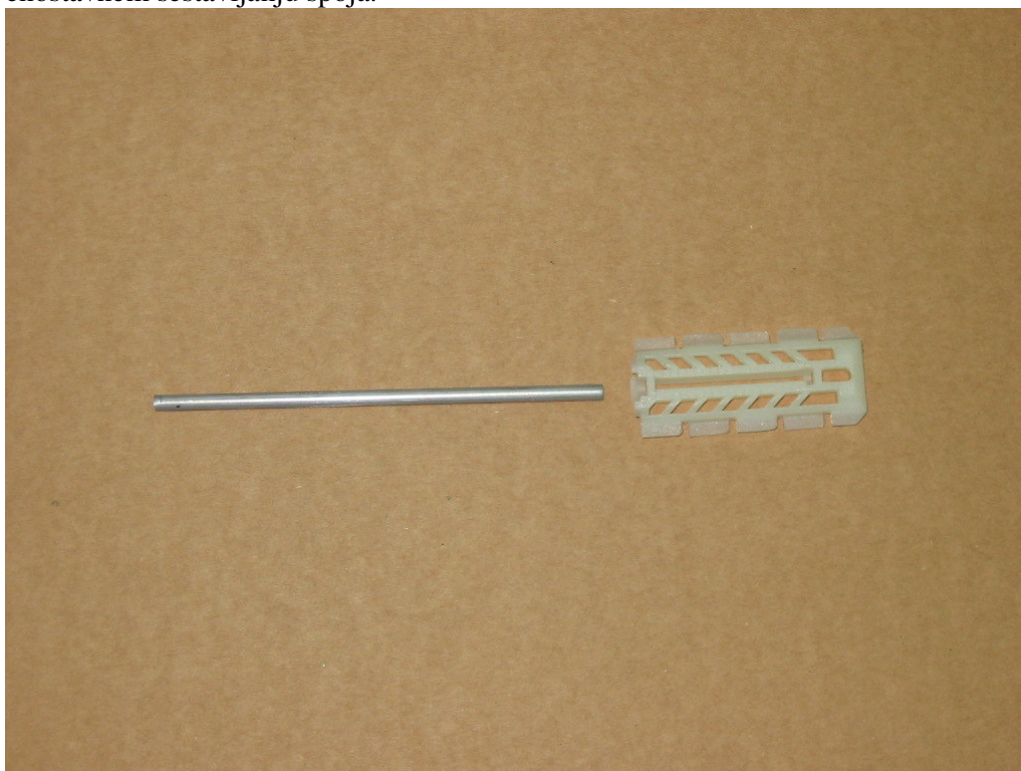

PROFIL 4508 se sestavlja na enak način kot profil 1808.



VEZAVE POD RAZLIČNIM KOTOM

ENOSTRANSKA VEZAVA

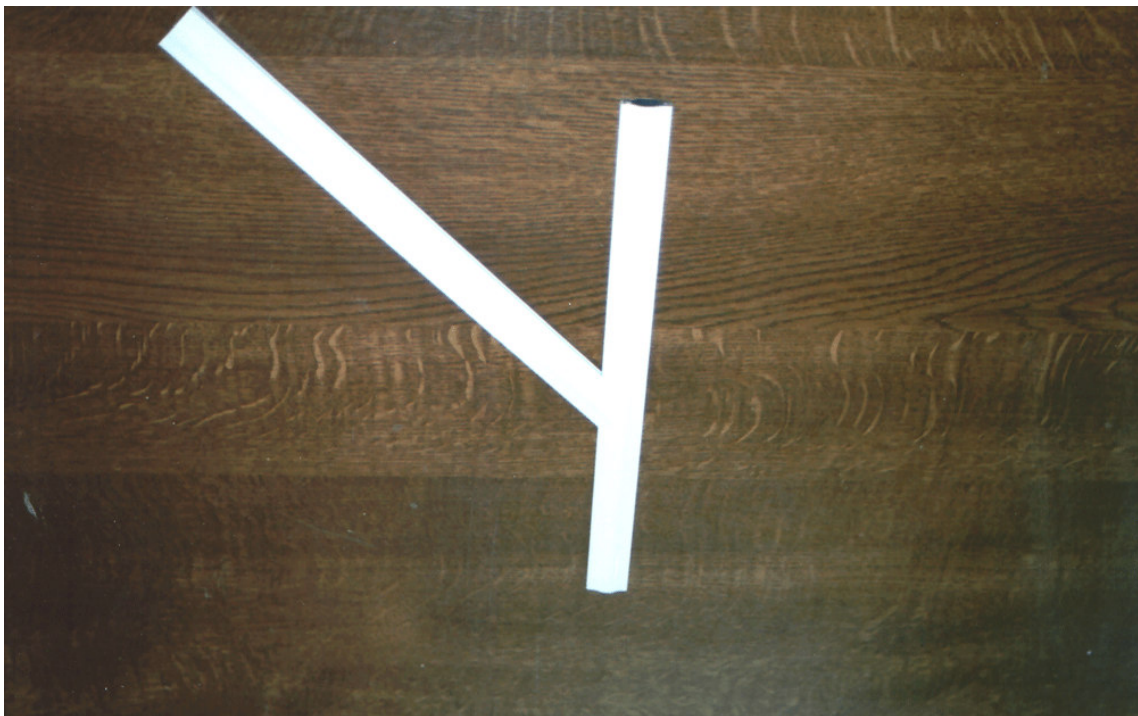
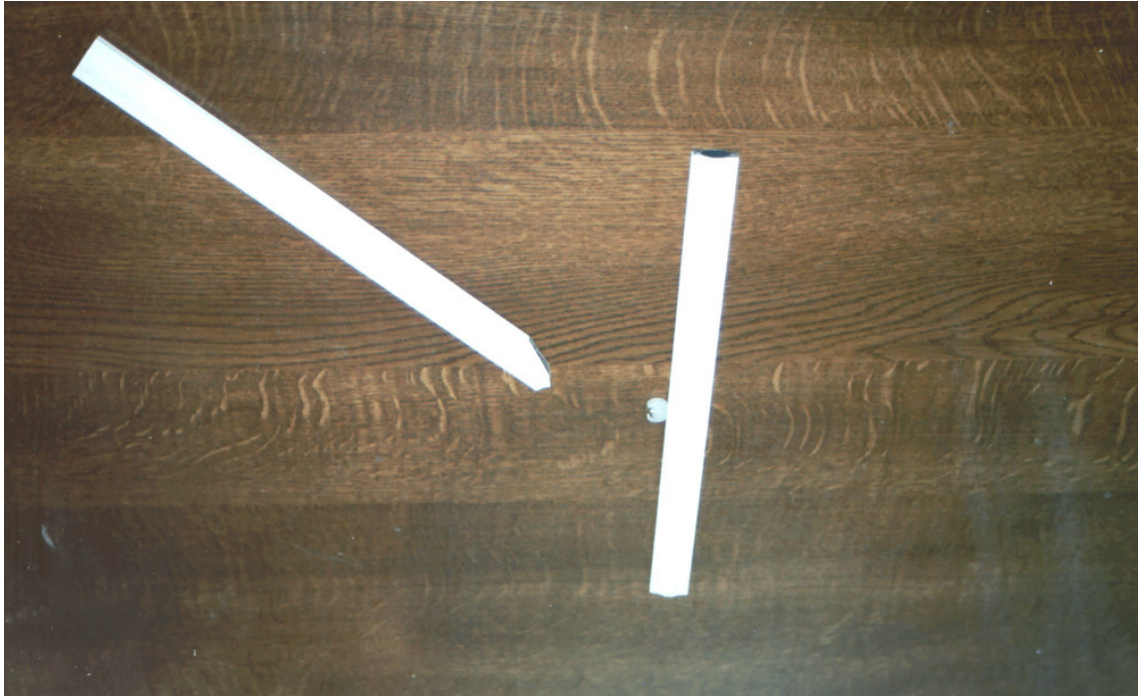

Za vse dimenzije se uporablja okrogli veznik za različne kote.

UNIVERZALNI VEZNIK 2000

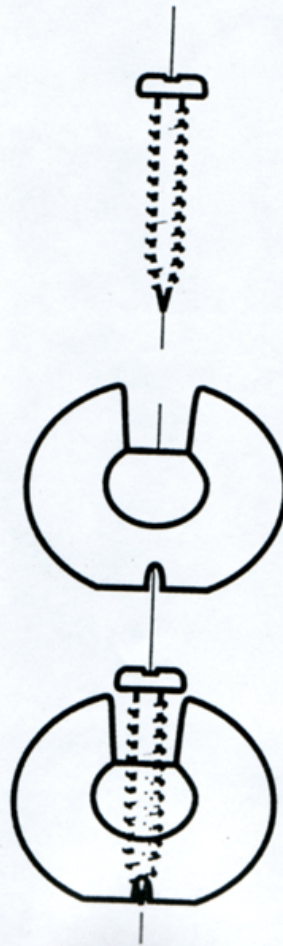

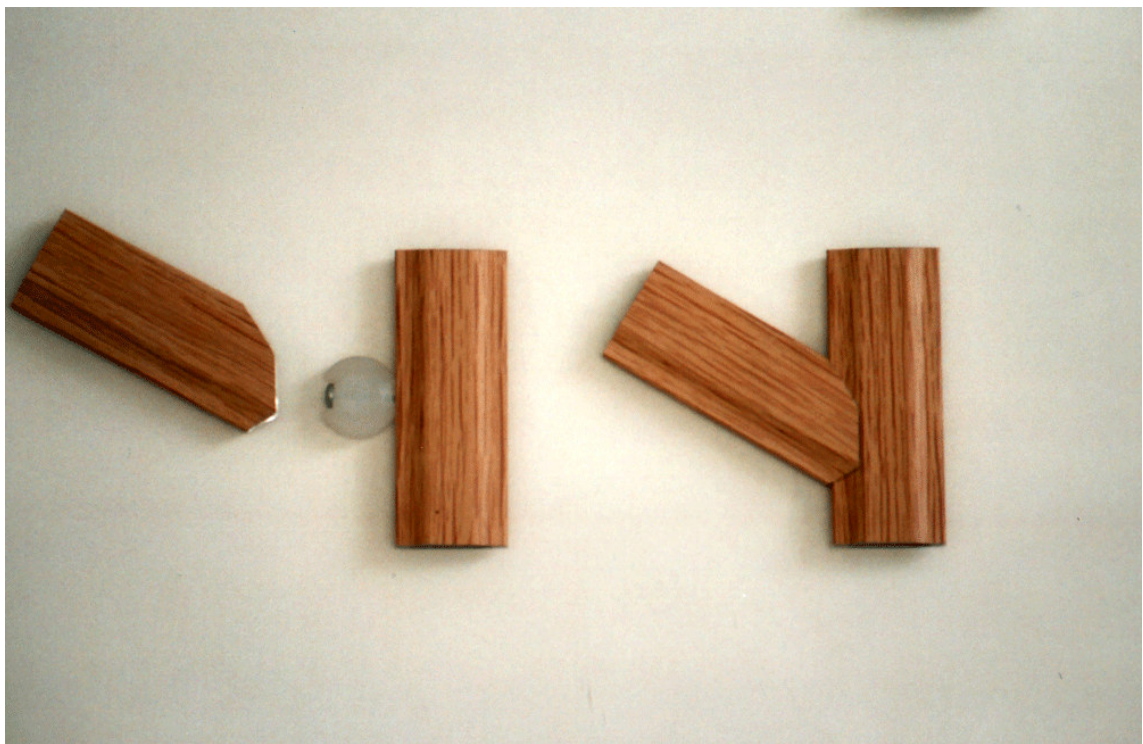
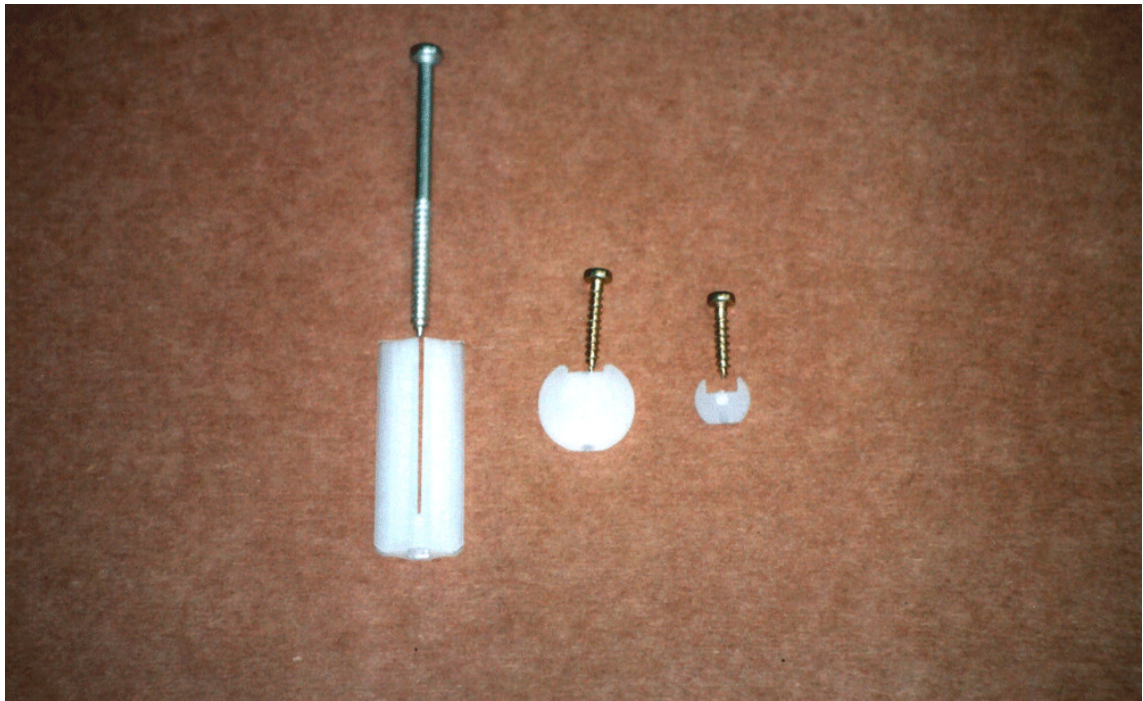

DVOSTRANSKA VEZAVA

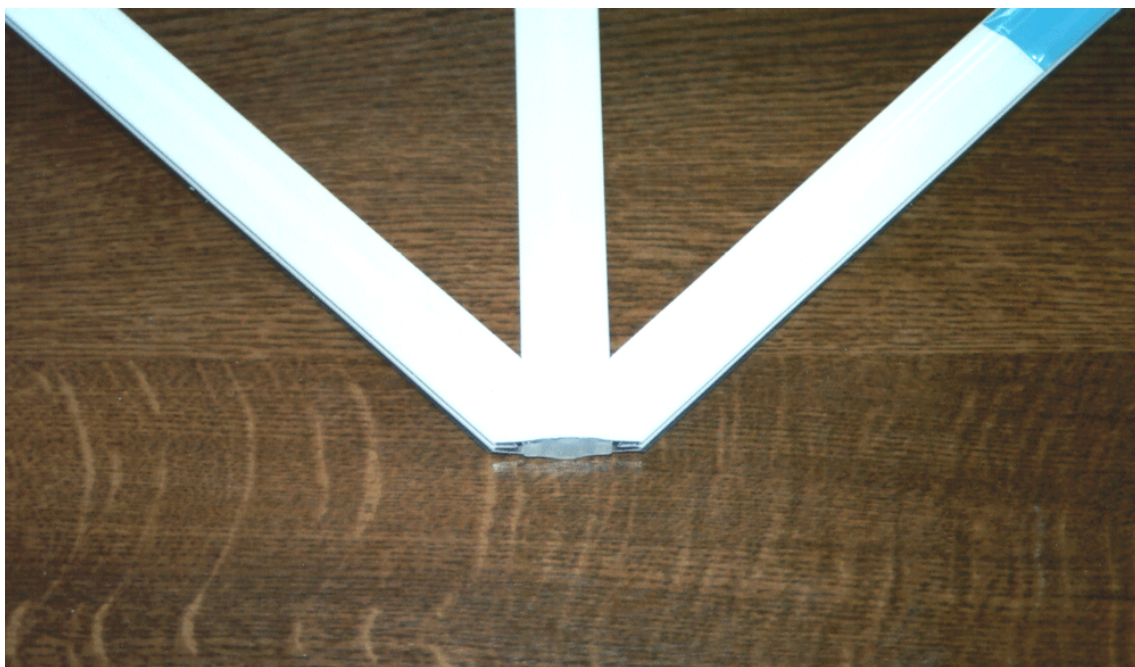
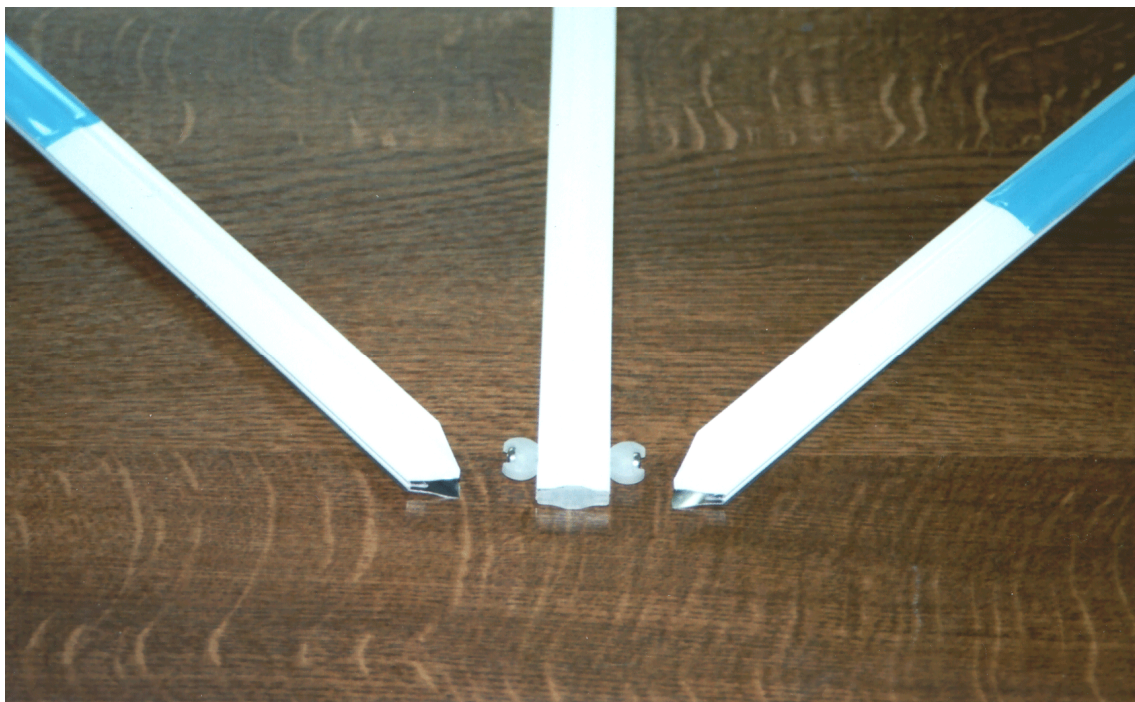

Pri dvostranski vezavi, ali zvezdi, je postopek enak kot pri enostranski vezavi.

T - VEZAVA

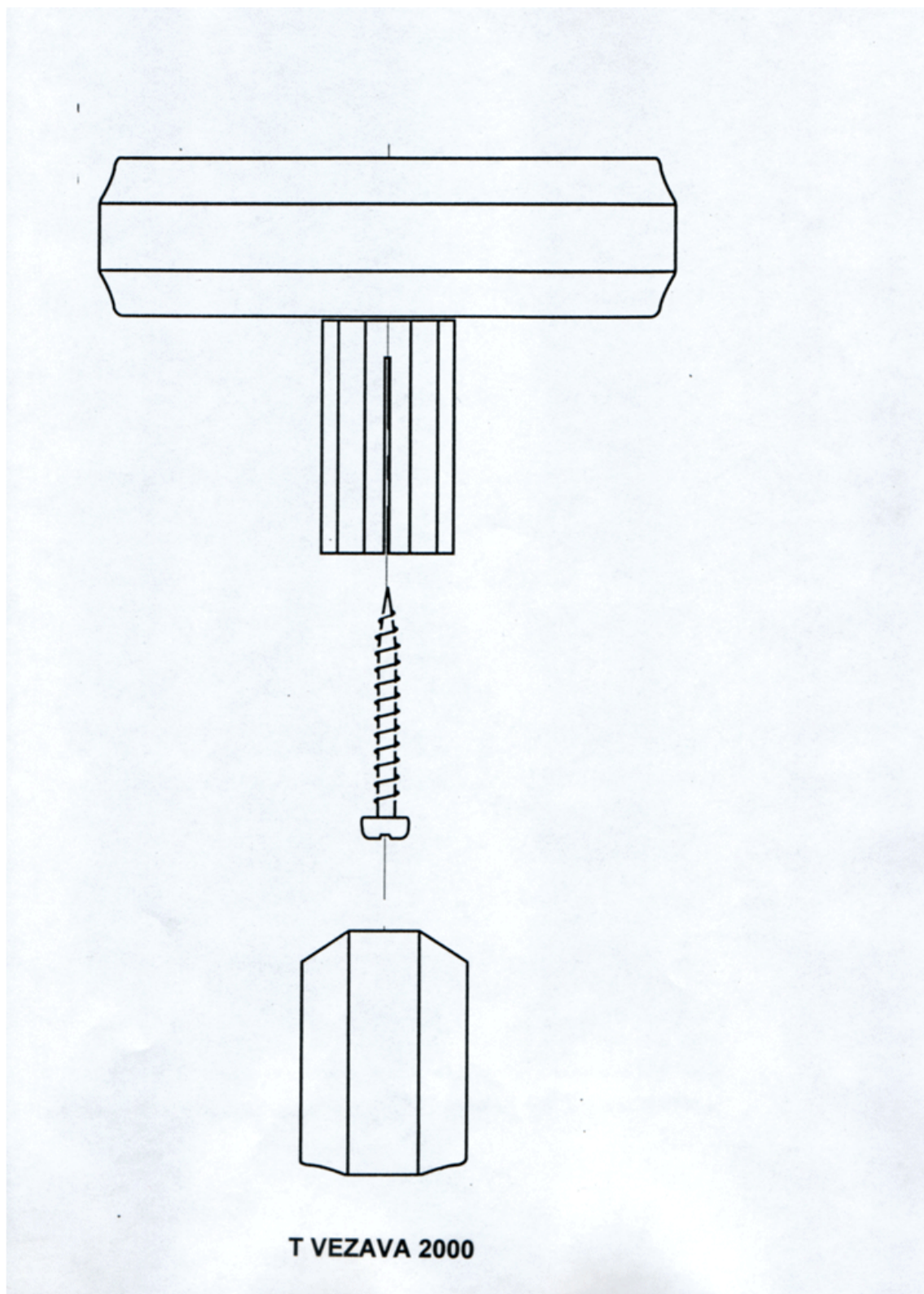

Za vse profile po enakem sistemu.

VEZAVA NA LOK

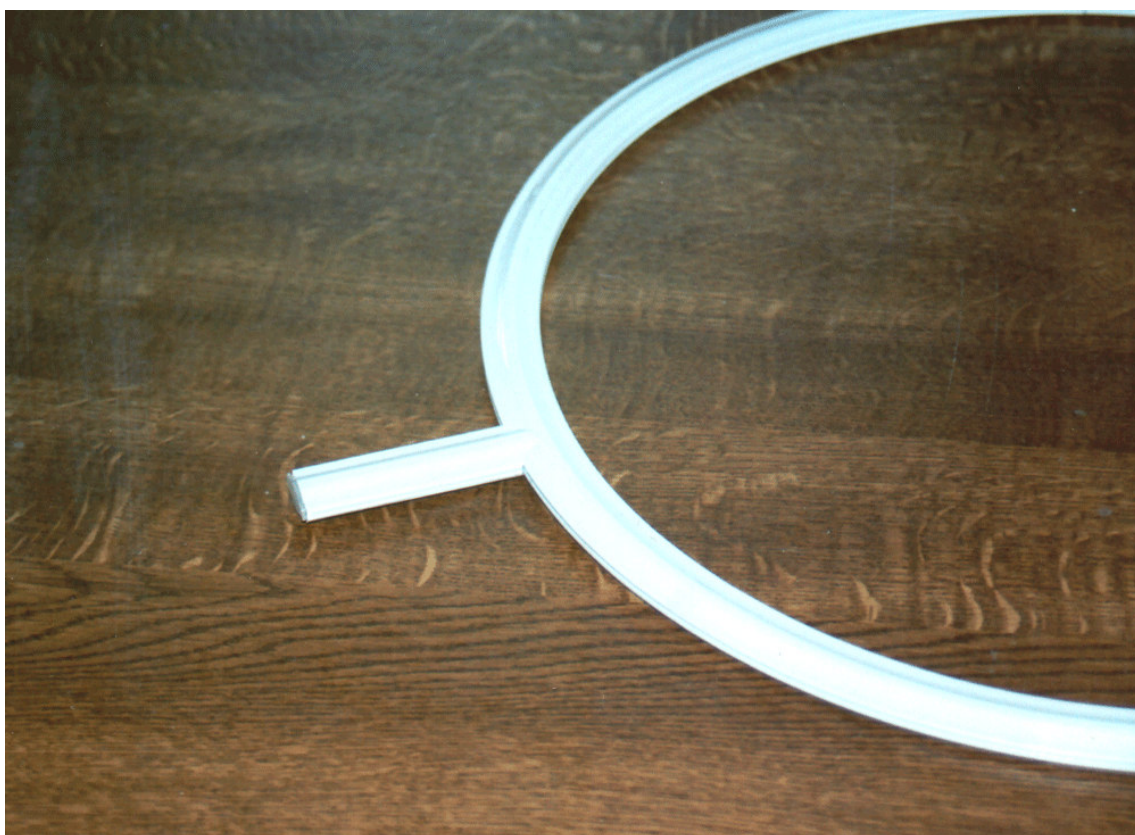
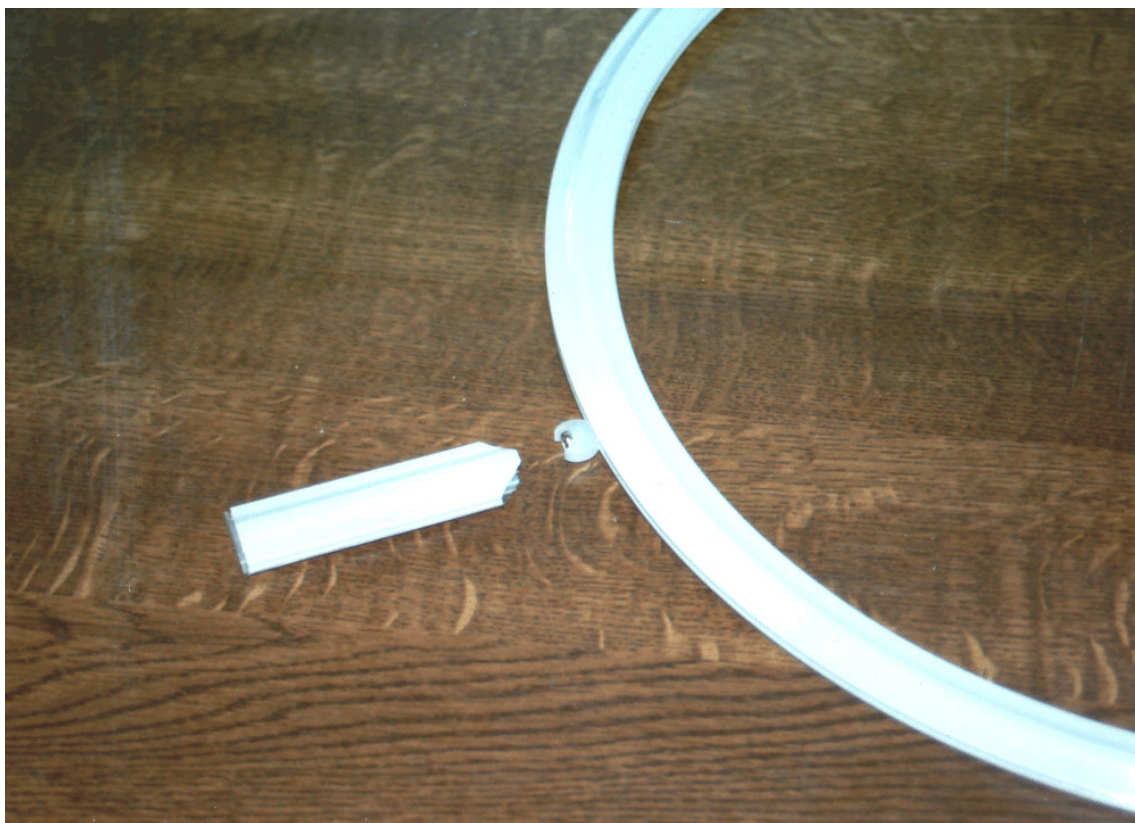

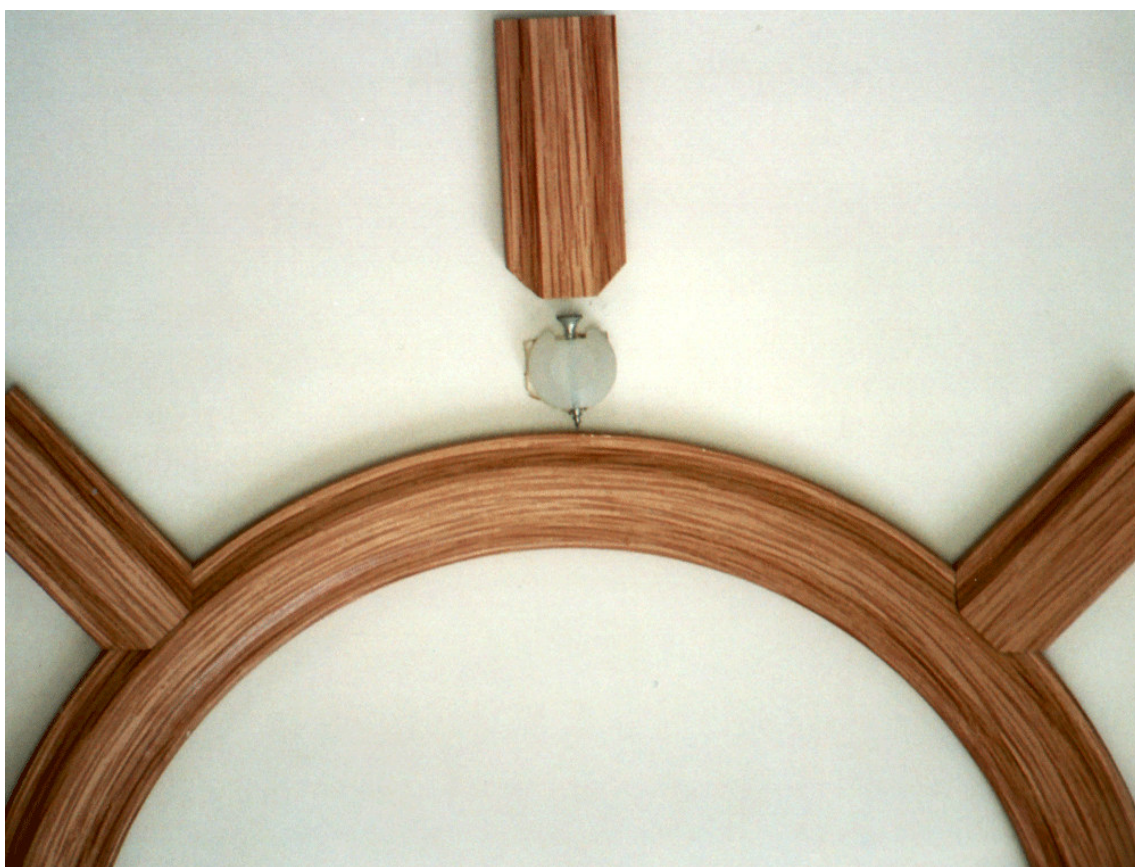
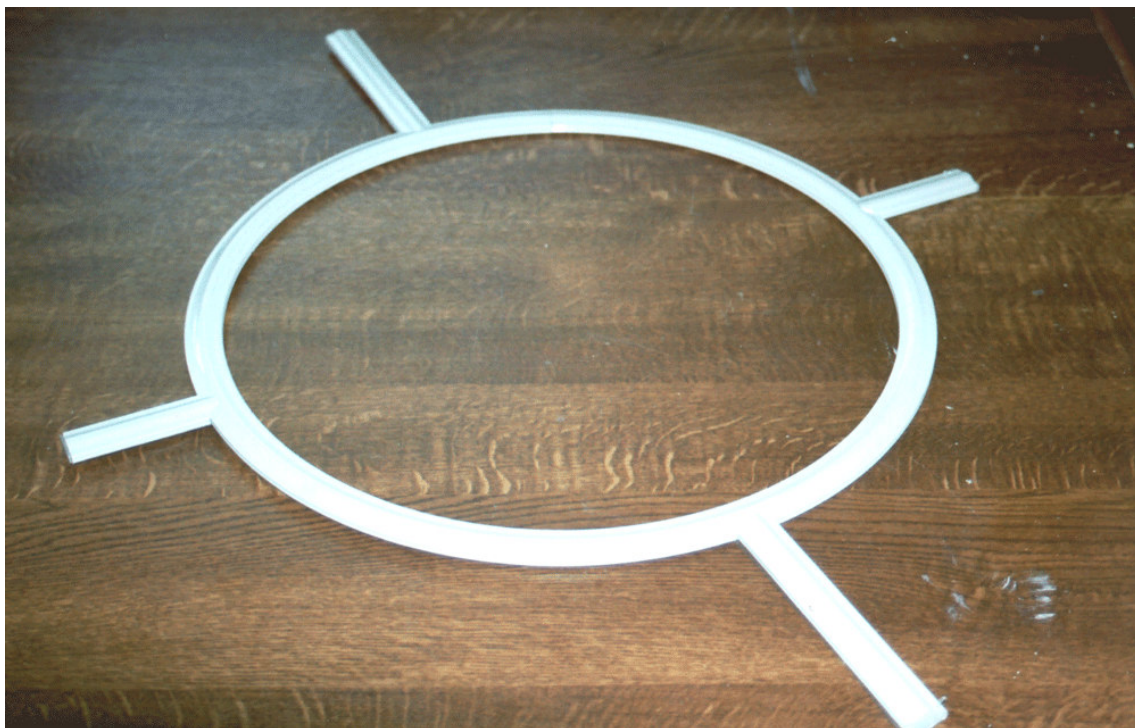

Za vse dimenzije se uporablja univerzalni okrogli veznik.

Y - IPSILON VEZAVA

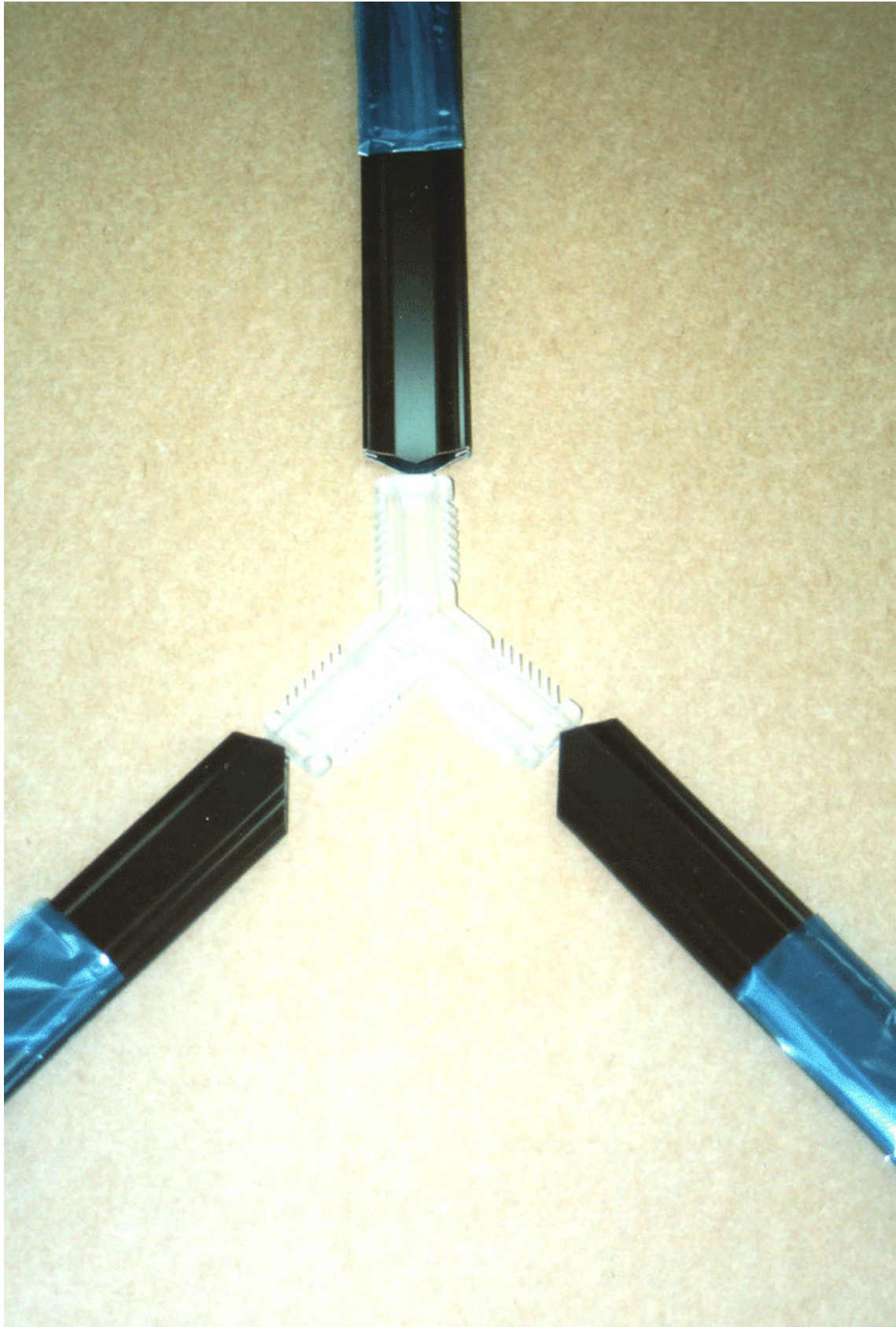

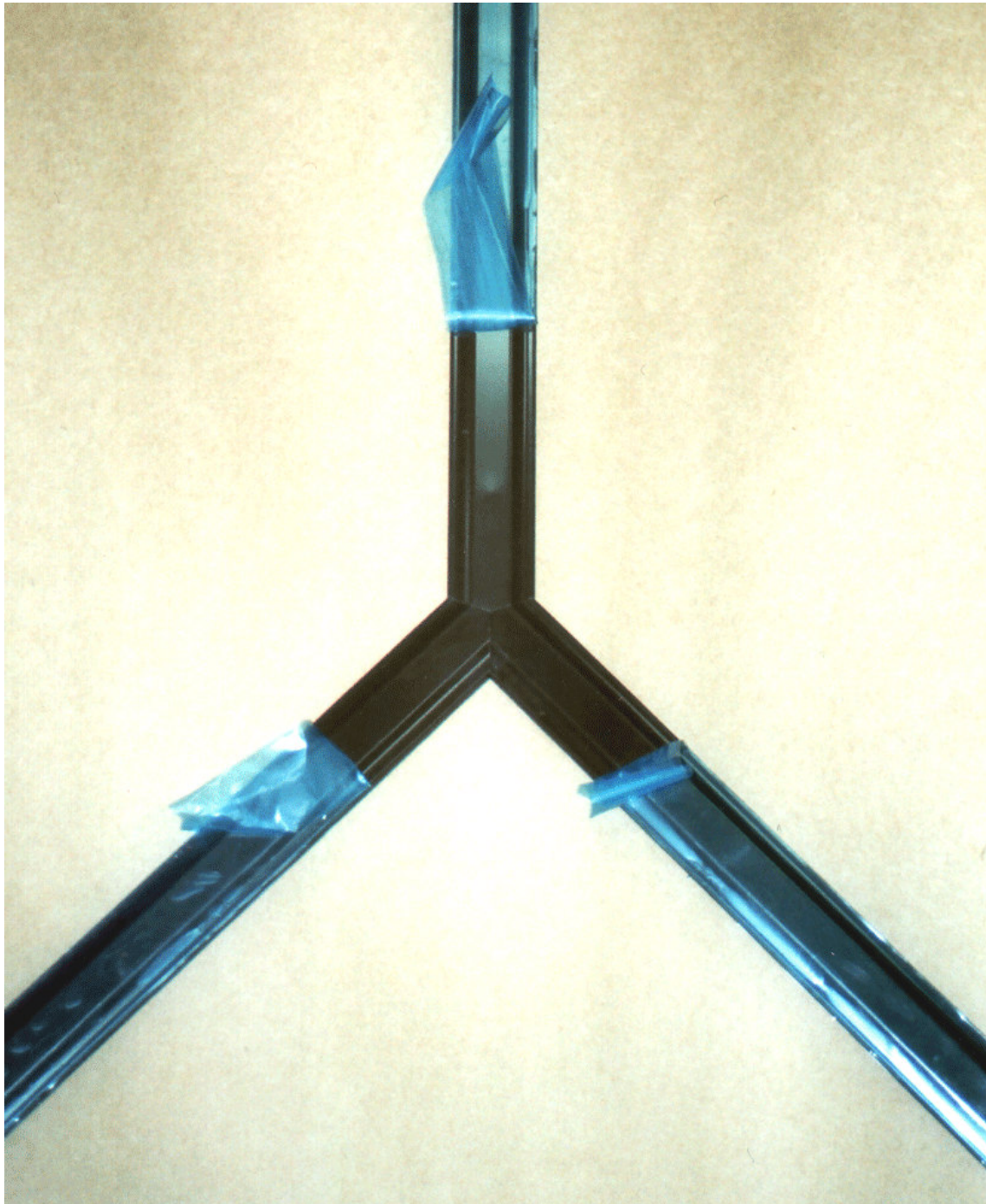

Uporabljamo posebne fiksne veznike za kote 60, 90 in 120°.
Vezniki obstajajo zgolj za profile v dimenzijah 1808 in 2608.

VEZAVA » SONCE «

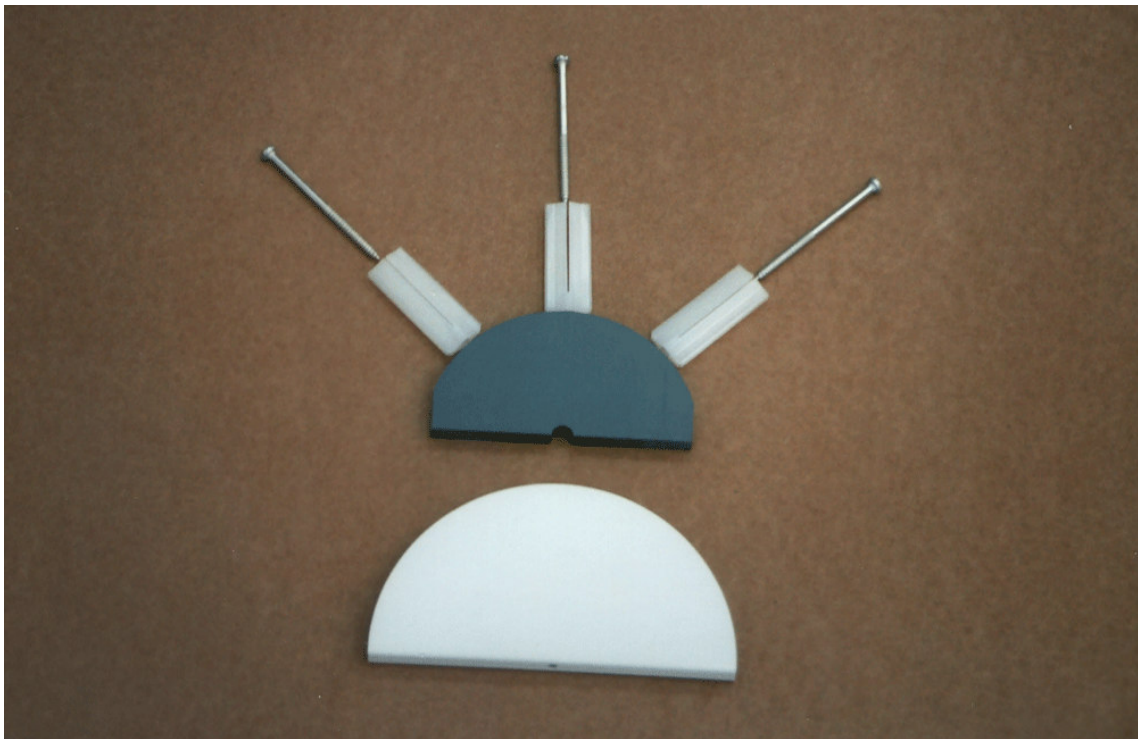
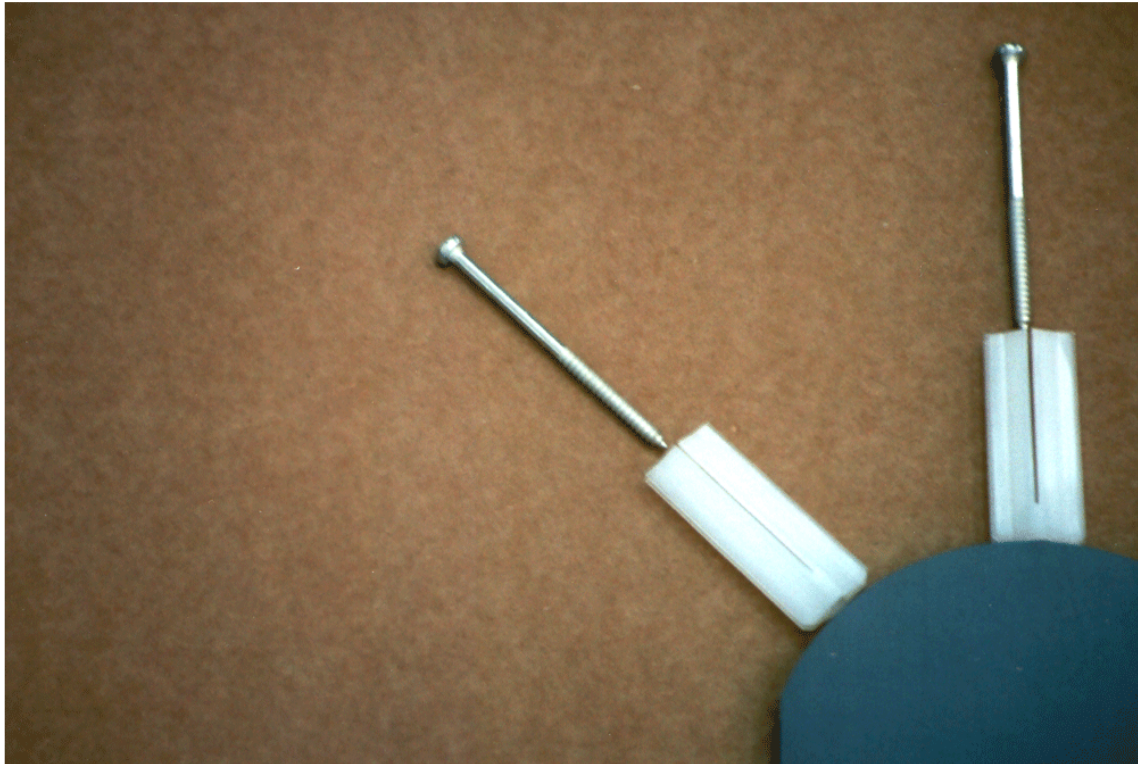

Samo za dimenzije 1808 in 2608

